

## 2' 8-Port Quasi-Omni Canister Antenna w/6° FET [1695-2690 & 3300-4200 MHz]

# GQ2408-08330

### Description:

- Quasi-Omni Pattern Canister Antenna for Outdoor DAS and Small Cells
- 6° Fixed Downtilt in Midband 1695-2690 MHz and C band 3300-4200 MHz
- 4x ports covering AWS/PCS/WCS/BRS bands (1695-2690 MHz)
- 4x ports covering CBRS/C bands (3300-4200 MHz)
- High gain in all frequency bands for coverage expansion
- CBRS/C bands gain enhancement for coverage alignment with Mid-band



### Electrical Specifications

Frequency Band [MHz]	1695-2200	2305-2360	2496-2690	3300-3550	3550-3700	3700-4200
Input Connector Type	4x 4.3-10(F)			4x 4.3-10(F)		
Gain (max., dBi)	11.4	11.2	10.8	12.2	13.3	13.3
Gain (BASTA, dBi)	10.4 ± 0.6	10.5 ± 0.4	10.1 ± 0.7	11.6 ± 0.7	12.1 ± 0.9	11.9 ± 0.9
Azimuth Beamwidth (°)	Omni (360)					
Elevation Beamwidth (°)	15.1	12.6	11.3	8.8	8.5	8.1
Downtilt (°)	6 Fixed					
VSWR / RL (dB)	1.5:1 / 14.0					
Isolation (dB)	20	23		23	25	
Max Power / Port (Watt)	200			150		
Max Total Input Power (Watt)	1000					
PIM @ 2x43 dBm (dBc)	-153					
Polarization (°)	Dual slant 45 (±45)					
Impedance (Ω)	50					

### Mechanical Specifications

Operating Temperature	-40° to 158°F (-40° to +70°C)
Antenna Weight	16.5 lbs (7.5 kg)
Antenna Bracket Weight (MK-06678 & MK-06679)	8.5 lbs (3.86 kg), 1x MK-06761 Bracket Per Antenna
Antenna Dimension (Diameter x Height)	10.0" (255.0 mm) x 23.5" (598.1mm)
Connector Type	8x 4.3-10(F)
Radome Material	ASA
Radome Color	Gray, Brown and Black
Environment Rating	Outdoor
Wind Survival Rating	150 mph (241 km/h)

## 2D Antenna Patterns

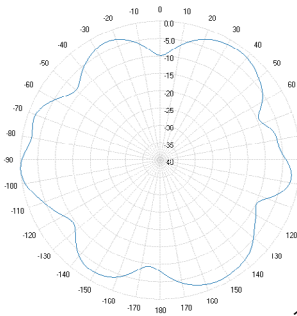

1755 MHz

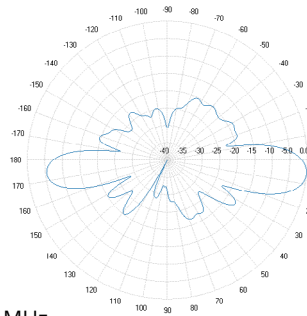

1915 MHz

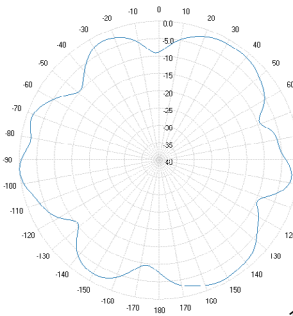

2320 MHz

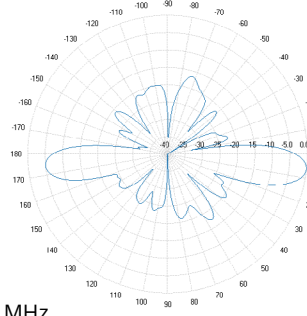

2500 MHz

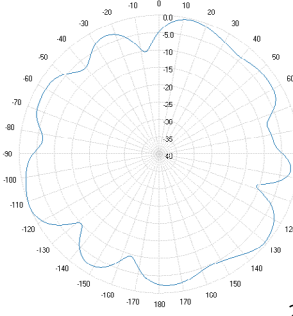

3450 MHz

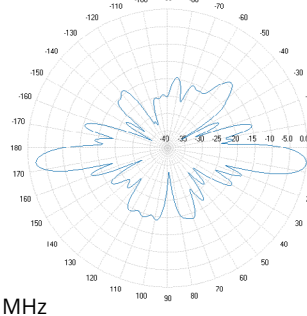

3690 MHz

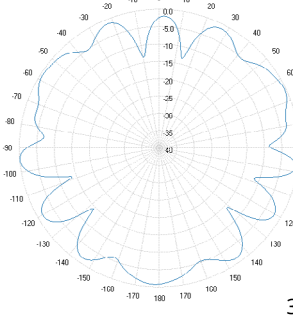

3860 MHz

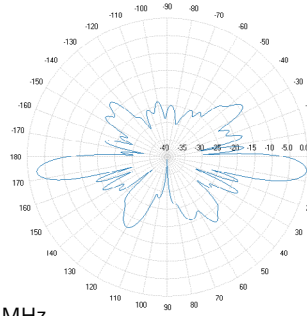

4100 MHz

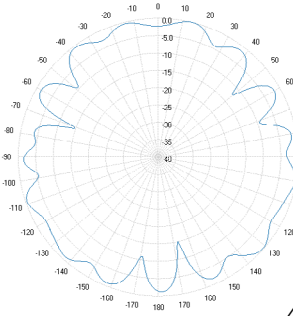

## Antenna Outline & Port Designation Details

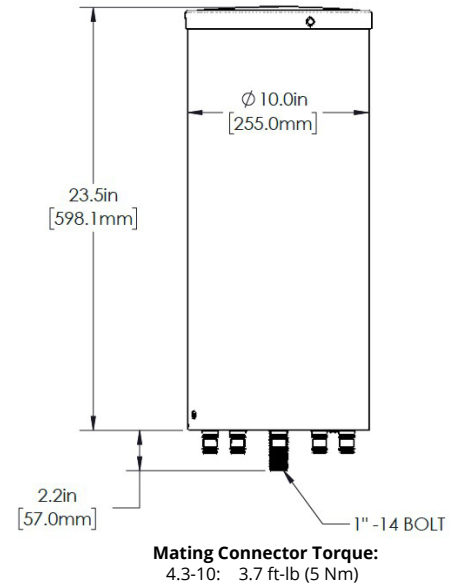
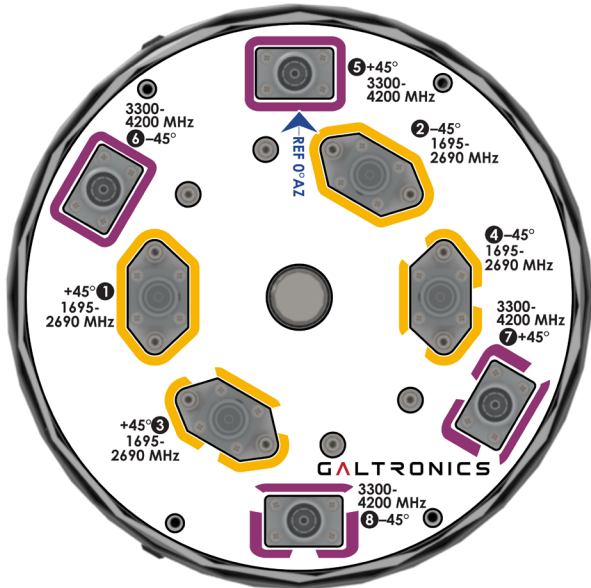

## Part Numbers & Ordering Options

Description	Color	Mounting Kit	Part Number
8-port Quasi-Omni Canister Antenna with 4.3-10(F) Connectors	Gray	Including MK-06761 mounting kit assembly	GQ2408-08330-112
	Brown		GQ2408-08330-612
	Black		GQ2408-08330-B12

## Mounting Brackets & Optional Accessories

Description	Part Number
<p><b>Mounting Kit Assembly (wind speed of 150 mph) [Included]</b></p> <p>The assembly kit includes a 1" Mount Rod Adapter (MK-06678: universal interface for pole top installation) and a Pole Top Mounting Bracket (MK-06679: a bracket base attached directly to wood, metal and cement poles).</p> <p><b>Note:</b> 1" Rod Adapter (MK-06678) and Pole Top Mounting Bracket (MK-06679) may be ordered separately.</p>	<p>MK-06761</p>