

2' 12-Port 45° Directional Panel Antenna [617-896, 1695-2690 and 3300-4200 MHz]

GP2412-08332

Description:

- 12-Port MIMO sector antenna for Small Cell and DAS applications
- 45° beamwidth dual-polarized covering low-band, mid-band AWS/PCS/WCS/BRS and CBR5/C-band
- 4x ports covering 617-896 MHz, 4x ports covering 1695-2690 MHz and 4x ports covering 3300-4200 MHz
- Includes wall/pole mounting bracket



Electrical Specifications

Frequency Band [MHz]	617-698	698-806	806-896	1695-2200	2305-2360	2496-2690	3300-3550	3550-3700	3700-4200
Input Connector Type	4x 4.3-10(F)			4x 4.3-10(F)			4x 4.3-10(F)		
Gain, max. (dBi)	9.3	9.6	9.9	14.7	14.4	15.0	14.4	15.2	15.8
Gain, avg. (dBi)	8.6	8.9	9.3	13.4	14.2	14.4	13.7	14.3	14.9
Horizontal Beamwidth (°)	53	48	42	53	41	36	49	47	41
Vertical Beamwidth (°)	71.8	81.2	83.8	27.7	22.3	22.0	17.8	16.2	14.3
Front-to-Back Ratio, 180° (dB)	28	25	25	38	39	35	42	43	38
Downtilt (°)	0 Fixed								
VSWR / RL (dB)	1.5:1 / 14.0								
Isolation (dB)	20								
PIM @ 2x43 dBm (dBc)	-153						-145		
Max Power / Port (W)	100								
Polarization (°)	Dual slant 45 (±45)								
Impedance (Ω)	50								

Mechanical Specifications

Operating Temperature	-40° to 158°F (-40° to +70°C)
Antenna Bracket Weight (MK-06853)	5.5 lbs (2.5 kg)
Antenna Bracket Weight (62-45-09)	7.5 lbs (3.4kg)
Antenna Weight	21.5 lbs (9.8 kg)
Antenna Dimensions (Height x Width x Depth)	24.5" (622mm) x 16.9" (430mm) x 7.2" (184 mm)
Radome Material	ASA
RoHS	Compliant
Radome Color	Gray
Environmental Rating	Outdoor

RFD#: 8332; Revision: R1; Release Date: April 13, 2026;

2D Antenna Patterns

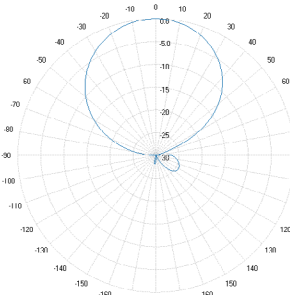

660 MHz

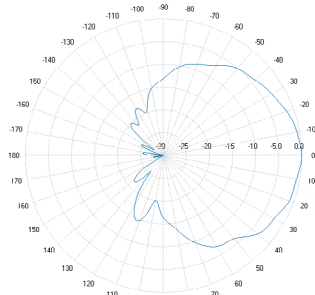

750 MHz

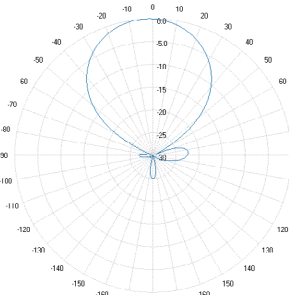

850 MHz

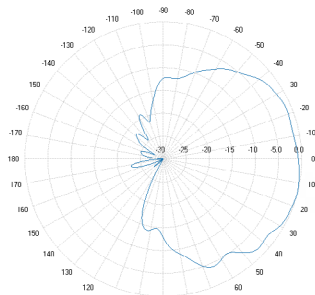

1780 MHz

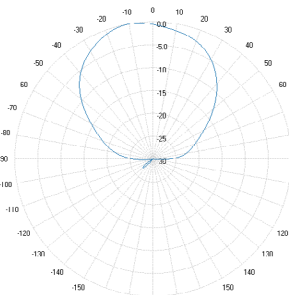

1970 MHz

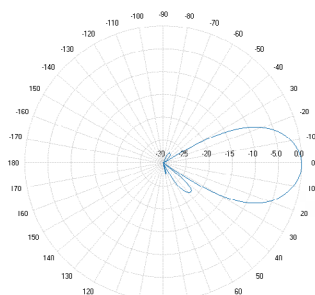

2315 MHz

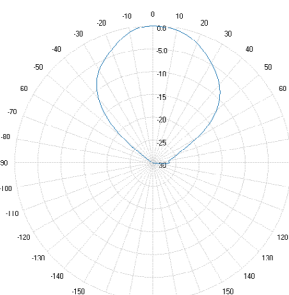

2620 MHz

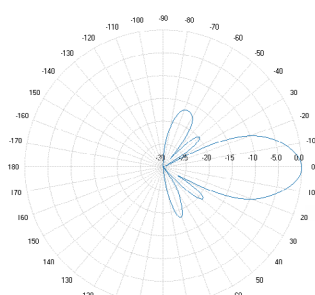

3450 MHz

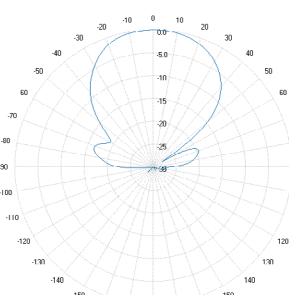

3650 MHz

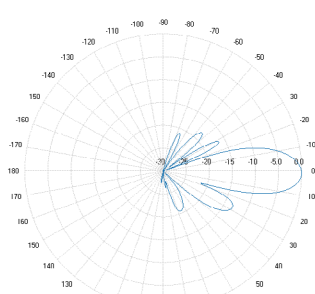

3960 MHz

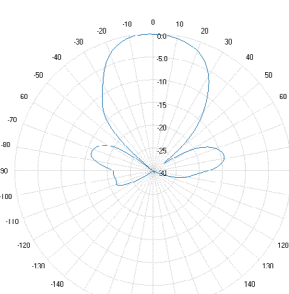

Antenna Outline & Port Designation Details

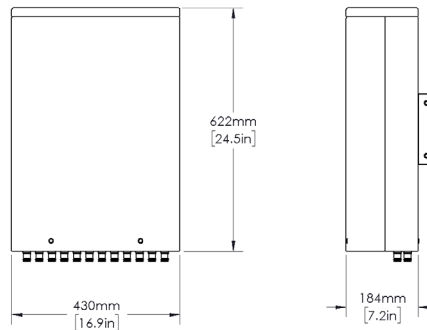
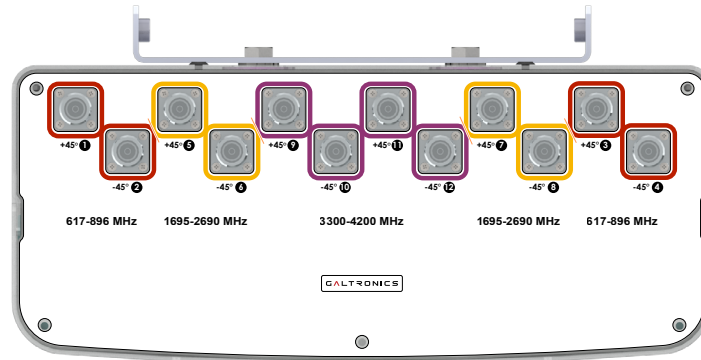



Mating Connector Torque:
4.3-10: 3.7 ft-lb (5 Nm)

Part Numbers & Ordering Options

Description	Color	Mounting Kit	Part Number
12-Port 45° Directional Panel Antenna with 12x 4.3-10(F) Connectors	Gray	Including MK-06853 Wall/Pole Mounting Kit	GP2412-08332-112

Part Numbers, Ordering Options and Accessories

Description	Part Number
<p>Heavy Duty Mounting Bracket (Wind speed of 150 mph) [Included] This standard mounting bracket is suitable for outdoor small cell antennas, and can be assembled onto wall and pole diameters ranging from 1.5" to 4".</p> <p>Note: The MK-06853 mounting bracket can also be ordered separately.</p>	 <p>MK-06853</p>
<p>Heavy Duty Dual Axis Adjustable Mounting Bracket (Wind speed of 150 mph) [Optional] This optional mounting bracket offers an easy installation solution to mount the antenna to either a horizontal or a vertical pole.</p>	 <p>62-45-09</p>