

30°/30° 8-Port Directional Panel Antenna [1695-2690 and 3300-4200 MHz]

GP2408-B7057

Description:

- Single-sector MIMO antenna for high capacity and stadium venues
- 30°/30° beam width dual-polarized covering AWS/PCS/WCS/BRS, and 3300-4200MHz CBRS/C Bands
- 4x ports for 1695-2690 MHz
- 4x ports for 3300-4200 MHz



1695-2690 & 3300-4200 MHz Directional Panel Antenna

Electrical Specifications

Frequency Band [MHz]	1695-2200	2305-2360	2496-2690	3300-3550	3550-3700	3700-4200
Input Connector Type	4x 4.3-10 (F)			4x 4.3-10 (F)		
Isolation (dB)	25					
VSWR /RL (dB)	1.5:1 / 14.0					
Impedance (Ω)	50					
Polarization (°)	Dual slant 45 (±45)					
Horizontal Beamwidth (°)	28	24	22	26	24	23
Vertical Beamwidth (°)	28	22	22	27	27	22
Gain max. (dBi)	16.3	16.5	16.7	15.2	16.1	16.5
Gain avg. (dBi)	15.3	16.1	16.5	14.9	15.2	15.7
Front-to-Back Ratio, 180° (dB)	35					
Max Power / Port (Watt)	100			50		
PIM @ 2x43 dBm (dBc)	-153			-145		

Mechanical Specifications

Operating Temperature	-40° to 158°F (-40° to +70°C)
Antenna Weight	16 lbs (7.25 kg)
Antenna Dimension (Height x Width x Depth)	23.5" (597.5mm) x 23.5" (597.5mm) x 4.2" (107.5 mm)
Radome Material	ASA
Radome Color	Gray
Environment Rating	Outdoor
Wind Survival Rating	150 mph (241 km/h)

2D Antenna Patterns

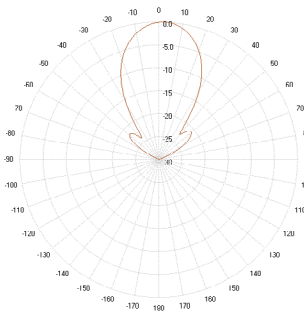

1880 MHz

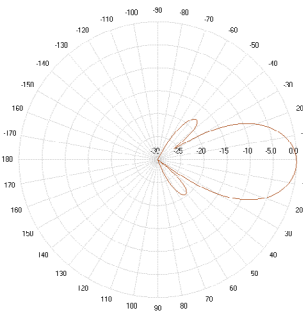

2320 MHz

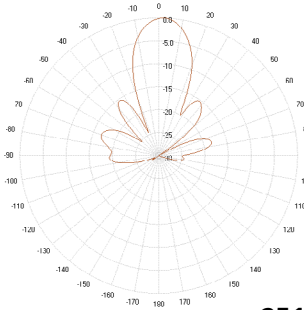
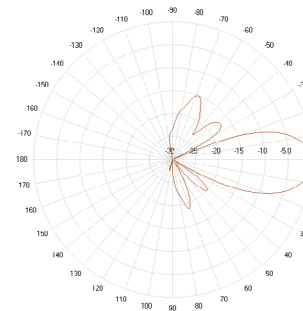
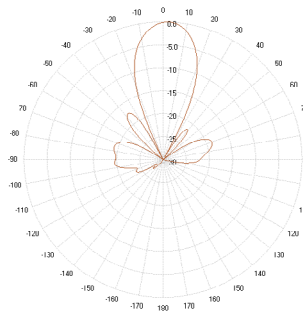

2510 MHz

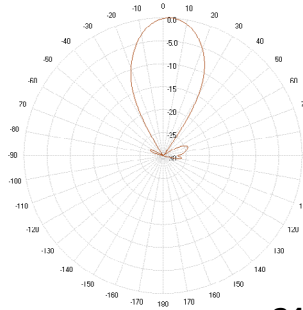
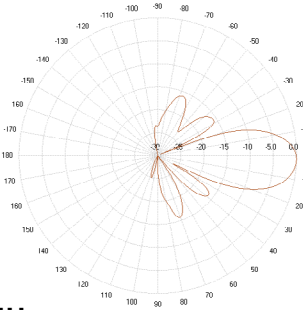

3450 MHz

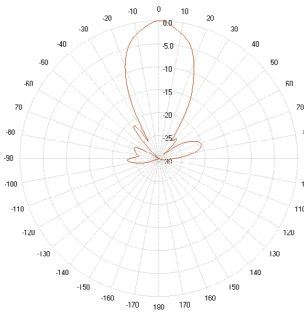
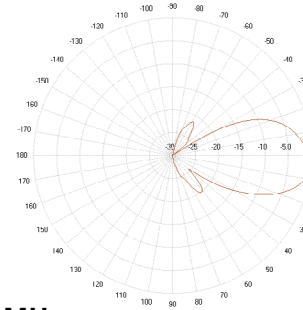

3690 MHz

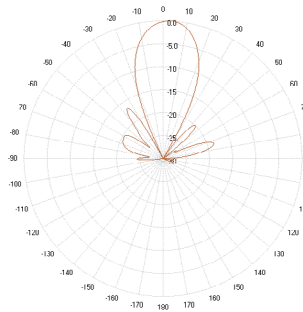
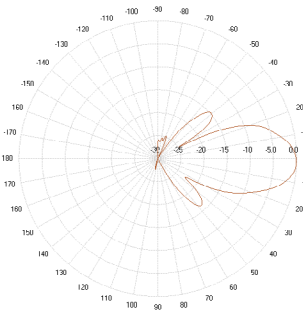

3920 MHz

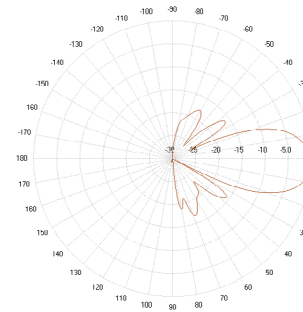

Antenna Rear View & Port Designation Details

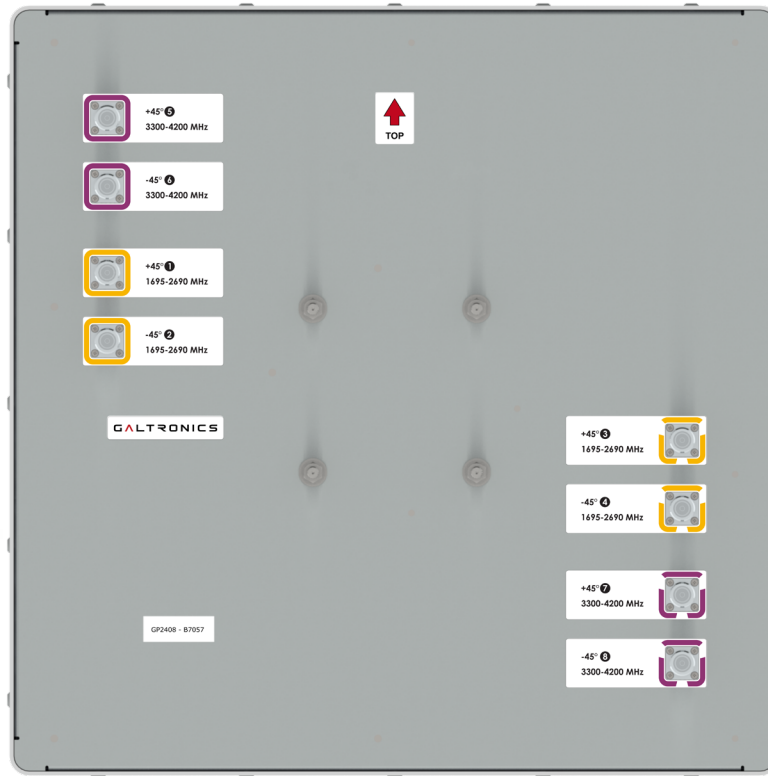

Mating Connector Torque:
4.3-10: 3.7 ft-lb (5 Nm)

Antenna Outline

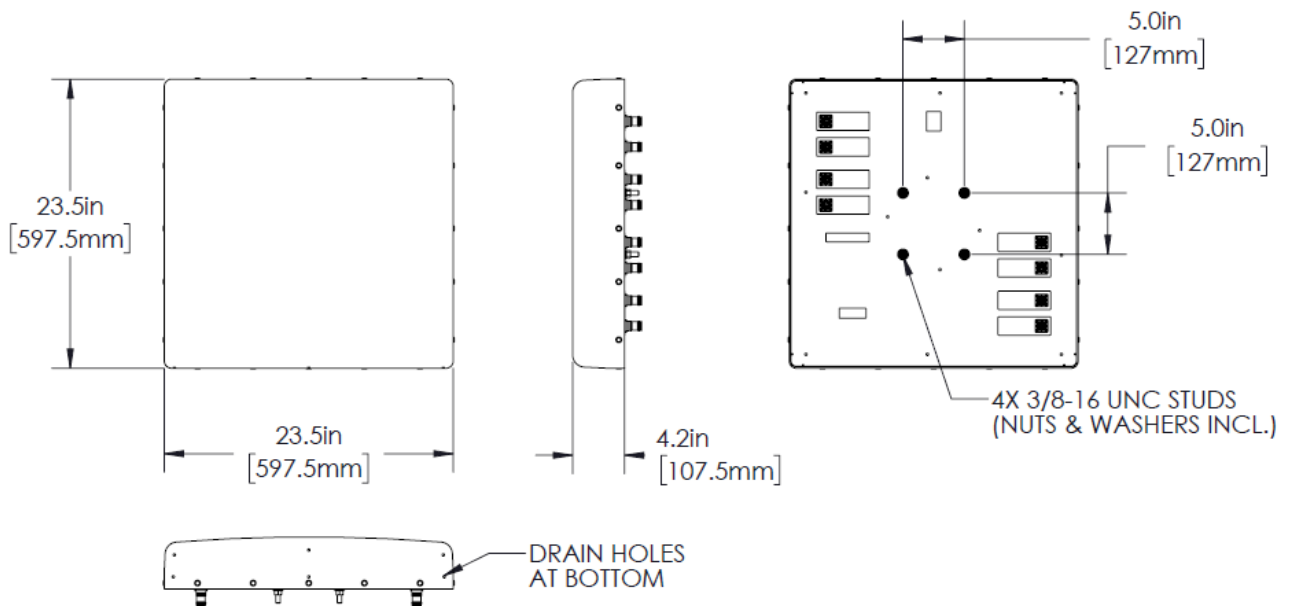



RFD# B7057 ; Revision: R2 ; Release Date: June 23, 2023

Part Numbers & Ordering Options

Description	Color	Mounting Kit	Part Number
8-Port 30° x 30° Pattern Directional Panel Antenna with 8x 4.3-10 (F) Connectors	Gray	Includes 62-45-09 mounting kit	GP2408-B7057-112

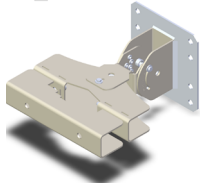
Mounting Kit and Accessories Part Numbers

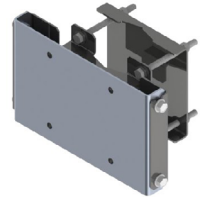
Description:	Part Number:
<p>Heavy Duty Mounting Bracket (150 mph) [INCLUDED]</p> <p>The mounting bracket allows wall and pole mounting with flexible and continuous antenna adjustment in the horizontal and vertical plane.</p>	 <p>62-45-09 (Included)</p>
<p>2 Axis Pole/Wall Mounting Bracket (150 mph) [OPTIONAL]</p> <p>Galtronics' mounting bracket offers an easy installation solution to mount Galtronics' stadium antennas to either a pole or a wall. When attaching the antenna to a wall please make sure to select appropriate fasteners (not included).</p>	 <p>62-28-09 (Sold Separately)</p>
<p>Heavy Duty Mounting Bracket (150 mph) [OPTIONAL]</p> <p>This standard mounting bracket offers an easy installation solution to mount the antenna to either a horizontal or a vertical pole.</p>	 <p>MK-07305 (Sold Separately)</p>