

## Mini 2x2 MIMO Indoor/Outdoor Directional Panel Antenna [617-960, 1695-2690 & 3300-4200 MHz]

### GI1002-07727

#### Description:

- Directional 2x2 MIMO antenna for DAS & Venue applications
- Dual-polarized design covering 600 MHz/LTE/CELL850/GSM900, AWS/PCS/WCS/BRS and 3300-4200 MHz band frequencies
- Rear cable with 2x 4.3-10(F) connectors
- Includes wall mounting bracket, optional 2-axis swivel bracket

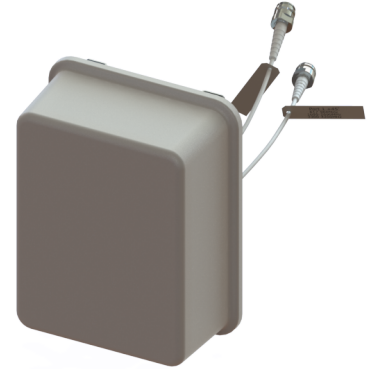

#### Electrical Specifications

Frequency Band [MHz]	617-698	698-896	896-960	1695-2200	2305-2360	2496-2690	3300-3550	3550-3700	3700-4200
Input Connector Type	2 x 4.3-10(F) w/ pigtails (12", 30cm) - rear cable launch								
Isolation (dB)	15			18			23		
VSWR / RL (dB)	1.67:1 / 12	1.5:1 / 14	1.67:1 / 12	1.5:1 / 14	1.67:1 / 12		1.5:1 / 14		
Impedance (Ω)	50								
Polarization (°)	Dual Slant 45 (±45)								
Horizontal Beamwidth (°)	99	98	84	78	80	77	60	55	64
Vertical Beamwidth (°)	86	82	72	61	74	59	58	48	56
Gain (dBi, max.)	6.7	7.2	6.2	5.8	5.7	6.4	7.6	8.0	7.9
Gain (dBi, avg.)	5.4	5.9	5.0	4.4	5.1	5.7	6.8	6.9	7.1
Front-to-Back Ratio (dB)	17.5	23.1	19.5	20.6	27.5	24.6	30.1	28.4	30.3
Downtilt (°)	0 FET								
Max Power / Port (Watt)	50								
PIM @ 2x43 dBm (dBc)	-153						-145		

#### Mechanical Specifications

Operating Temperature	-40° to 158°F (-40° to +70°C)
Antenna Weight	2.5 lbs (1.14 kg)
Mounting Bracket Weight (62-29-03, Optional)	1.3 lbs (0.60 kg)
Antenna Dimension (HxWxD)	10.2" (259 mm) x 8.0" (203 mm) x 3.9" (100 mm)
Radome Material & Color	ASA, White
Pigtail	Plenum Rated
RoHS	Compliant
Environmental Rating	Indoor / Outdoor

RFD#: 7727; Revision: R2; Release Date: November 21, 2025;

## 3D Antenna Patterns

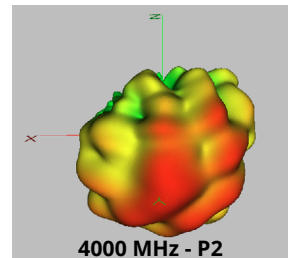
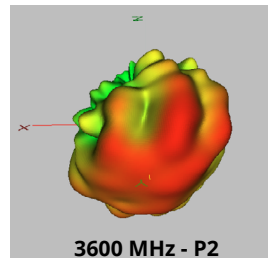
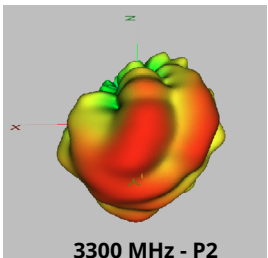
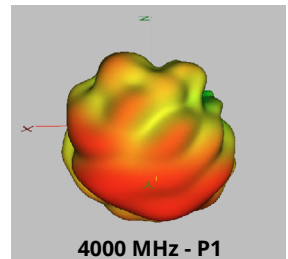
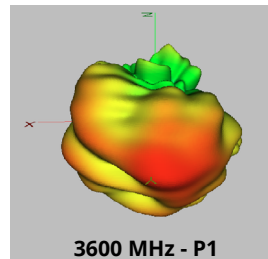
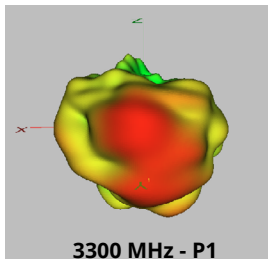
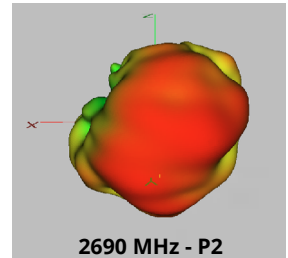
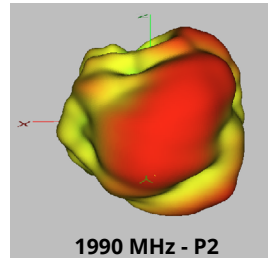
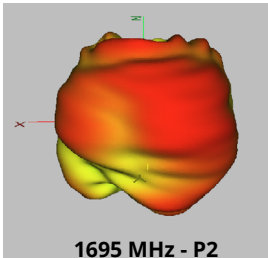
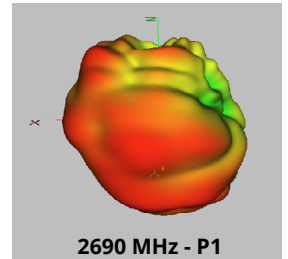
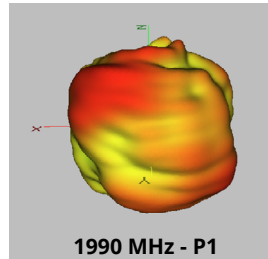
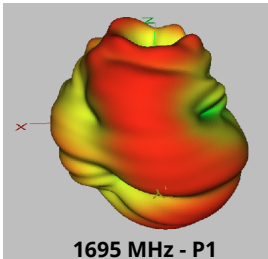
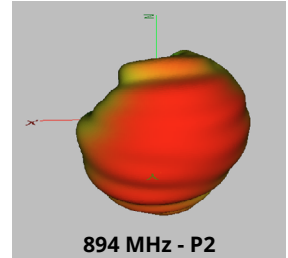
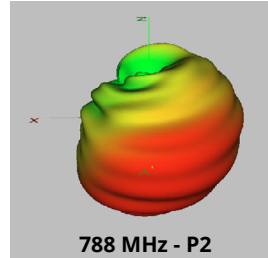
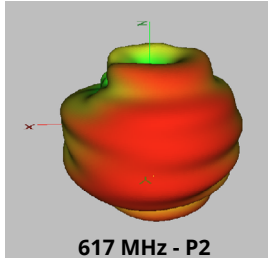
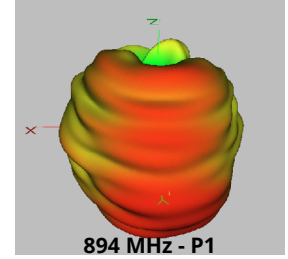
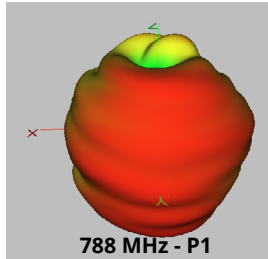
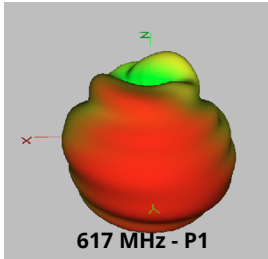

**3D Pattern Note:**

3D images above denote Z-axis (green) pointed towards ceiling and Y-axis pointing towards front of antenna, which corresponds to 0° in pattern files.

RFD#: 7727; Revision: R2; Release Date: November 21, 2025;

## Antenna Outline

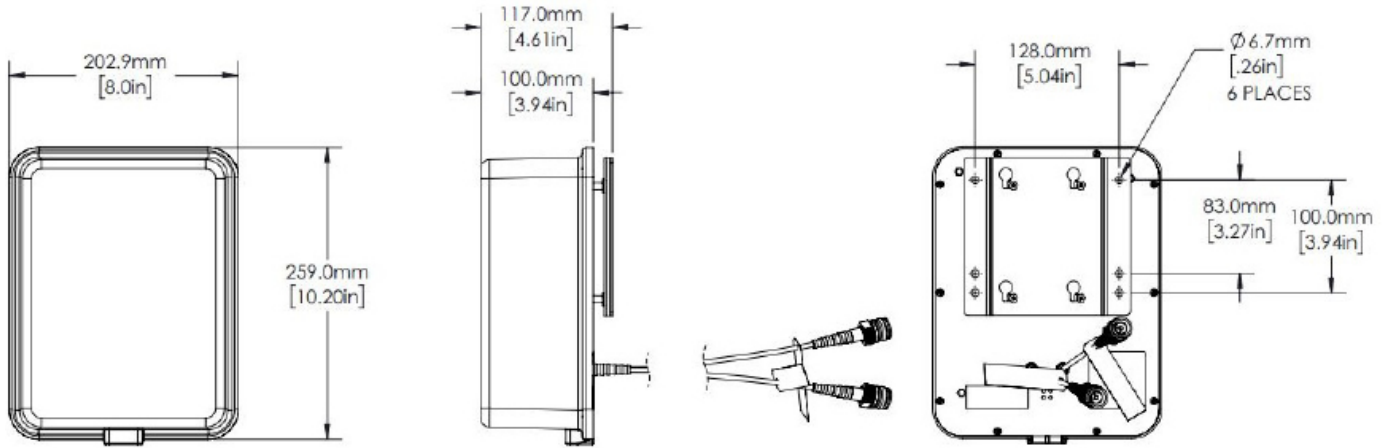

**Mating Connector Torque:**  
4.3-10: 3.7 ft-lb (5 Nm)

## Part Numbers, Ordering Options

Description	Color	Mounting Kit	Part Number
Mini Indoor/Outdoor Directional Panel Antenna w/2 x 4.3/10(F) Rear cable launch	White	Including Wall Mount Bracket	GI1002-07727-112

## Part Numbers, Ordering Options and Accessories

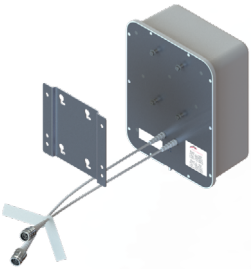
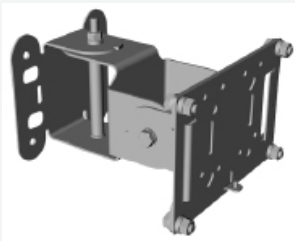
Description	Part Number
<p><b>Mounting Plate Installation [Included]</b></p> <p>Attach the mounting plate to the wall. Slide the antenna onto the mounting plate.</p>	
<p><b>Swivel Mounting Bracket [Optional]</b></p> <p>The swivel mounting bracket allows the antenna to be articulated +/- 45° in both the horizontal and vertical plane. The bracket can be mounted on a pole or on a wall.</p>	 <p>62-29-03</p>

RFD#: 7727; Revision: R2; Release Date: November 21, 2025;