

60"x2" 8-Port Outdoor Omni Whip Antenna with 0° Fixed Tilt [1695-2200, 1695-2690 MHz]

GO6008-07807

Description:

- Outdoor Whip Antenna for DAS and Small Cells
- 4x ports for AWS/PCS/WCS/BRS Bands 1695-2690 MHz
- 4x ports for AWS/PCS Bands 1695-2200 MHz

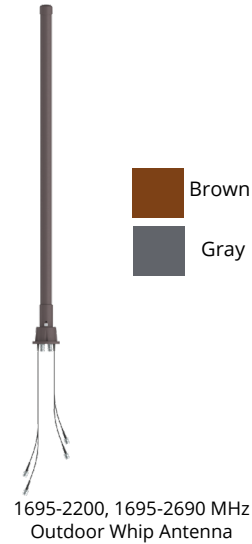

Electrical Specifications

Frequency Band [MHz]	1695-1880	1850-1990	1920-2200	1695-1880	1850-1990	1920-2200	2305-2360	2496-2690
Input Connector Type	4x 4.3-10 (F) pigtail			4x 4.3-10 (F)				
Port Designator	P1 - P4			P5 - P8				
Port to Port Isolation (dB, min.)	20			20				
VSWR (max.) / RL (min.)	1.5:1 / 14.0 dB							
Impedance	50 Ω							
Polarization	Vertical			Vertical				
Horizontal Beamwidth (°)	360							
Vertical Beamwidth (°)	54	49	48	54	50	48	44	39
Gain (dBi, max.)	4.8	5.1	5.5	3.9	4.1	4.6	5.0	6.5
Gain (dBi, avg.)	3.6	4.1	4.6	3.1	3.4	3.8	4.6	5.8
Downtilt	0° fixed							
Max Power (Watts) / Port	50							
PIM @ 2x43 dBm	<-153 dBc							

Mechanical Specifications

Operating Temperature	-40° to 158°F (-40° to +70°C)
Antenna Weight	7.0 lbs (3.2 kg)
Antenna Diameter	2" (51 mm)
Antenna Height	60" (1524 mm)
Radome Material	Fiberglass / PC-ASA
Environment Rating	Outdoor
Wind Survival Rating	150 mph (241 km/h)

2D Antenna Patterns

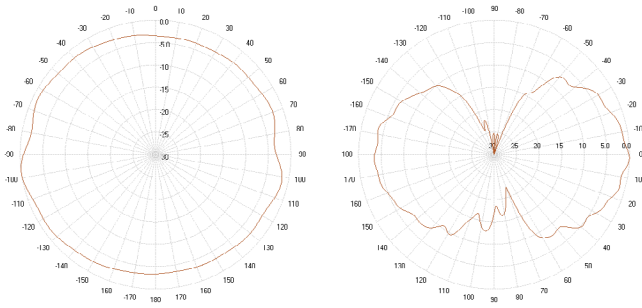

P4 1865 MHz

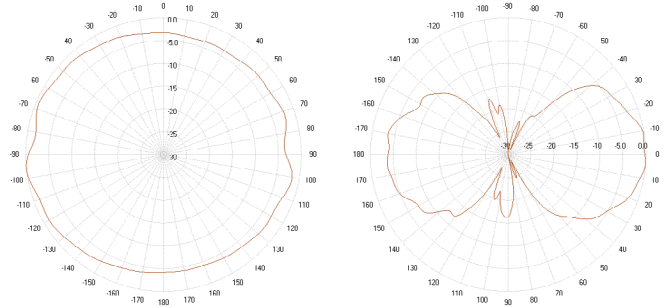

P3 1980 MHz

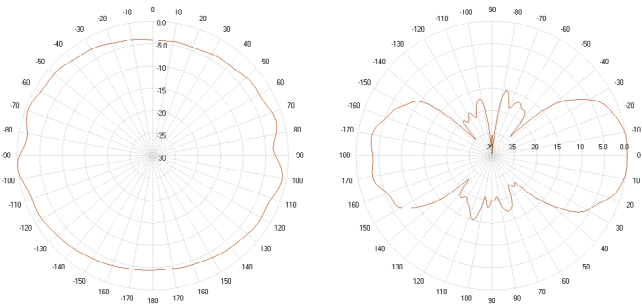

P4 2200 MHz

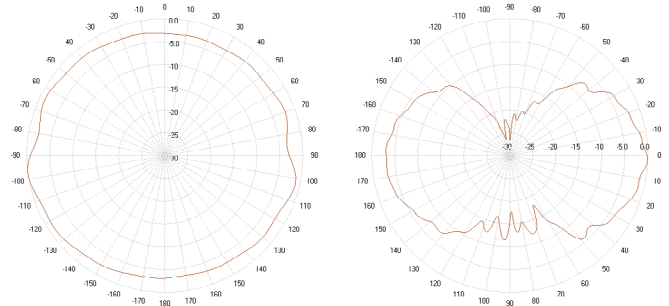

P6 1865 MHz

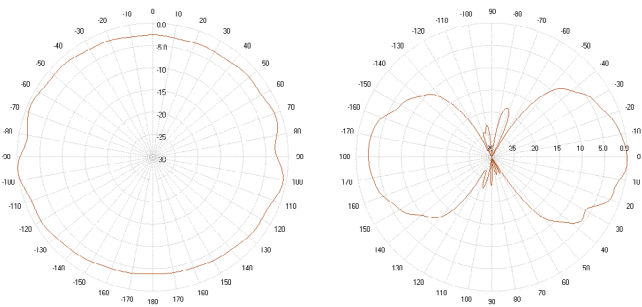

P5 1980 MHz

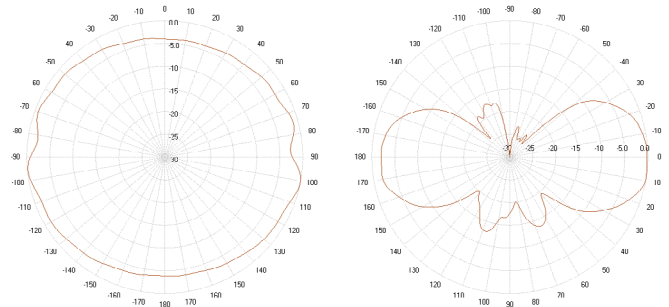

P8 2200 MHz

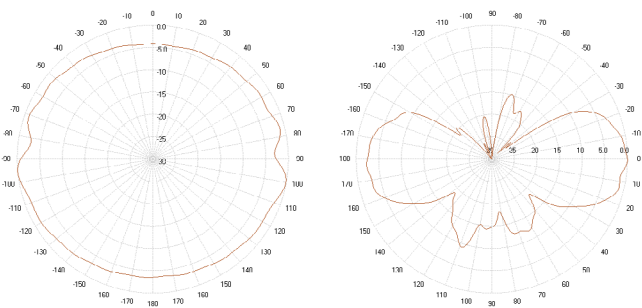

P8 2360 MHz

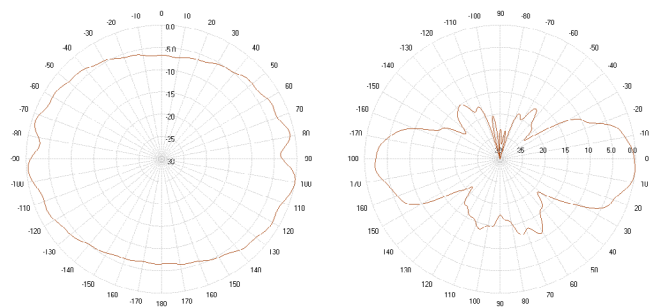

P8 2690 MHz

Antenna Outline and Bottom View with Labelling

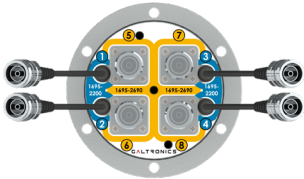

Bottom View

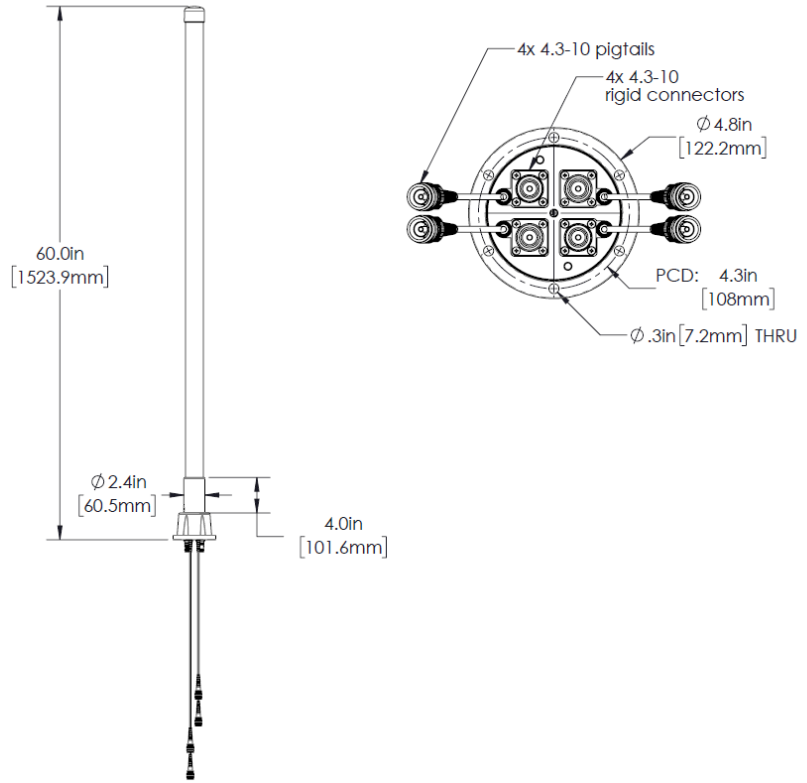





Outline

Mating Male Connector Torque:
4.3-10: 3.7 ft-lb (5 Nm)

Part Numbers, Ordering Options and Accessories

Description	Color	Included Accessories	Part Number
60"x2" 8-Port Outdoor Omni Whip Antenna with 0° Fixed Tilt 1695-2690MHz, 4x rigidly mounted 4.3-10 (F) and 4x pigtail 4.3-10 (F)	Brown 10049 (Fed Std 595)	None	GO6008-07807-611
		MK-06696 Side Mount Bracket Kit (Unpainted)	GO6008-07807-612
	Gray/Silver 26373 (Fed Std 595)	Gray/Silver 26373 MK-06766 Spacer Collar	GO6008-07807-112

Mounting Kit and Part Number	
Description:	Part Number:
Side Mount Bracket	 MK-06696  MK-06766 kit with Whip Antenna
Antenna Spacer Collar	 MK-6766
Top Mount Bracket	 MK-6840 (Sold Separately)