

18" 6-Port Quasi-Omni Pattern Canister Antenna [698-896 and 1695-2690 MHz]

GQ1806-06832

Description:

- Compact Height Quasi-Omni Pattern Canister Antenna for Outdoor DAS and Small Cells
- 2x ports for Low Band 698-896 MHz
- 4x ports for AWS/PCS/WCS/BRS Band 1695-2690 MHz
- 18" Height for Zoning Restricted Applications
- Side and Top Mount Bracket Options Available



698-896 and 1695-2690 MHz
Quasi-Omni Pattern Canister Antenna

Electrical Specifications

Frequency Band [MHz]	698-806	806-896	1695-2180	2305-2360	2496-2690
Input Connector Type	2x 4.3-10(F)		4x 4.3-10(F)		
Isolation (min.)	25 dB		20 dB		
VSWR (max.) / RL (min.)	1.5:1 / 14.0 dB				
Impedance	50 Ω				
Polarization	Dual slant 45° (±45°)				
Horizontal Beamwidth	Omni (360°)				
Vertical Beamwidth	42.9°	36.4°	22.4°	18.4°	16.8°
Gain (max.)	6.1 dBi	6.2 dBi	8.6 dBi	9.1 dBi	8.9 dBi
Gain (avg.)	5.5 dBi	6.0 dBi	7.6 dBi	8.2 dBi	8.1 dBi
Downtilt	0° Fixed				
Max Power / Port	100 Watts				
PIM @ 2x43 dBm	<-153 dBc				

2D Antenna Patterns

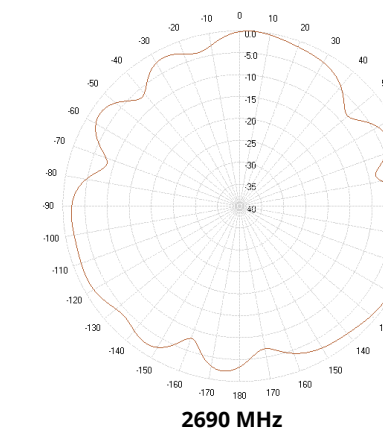
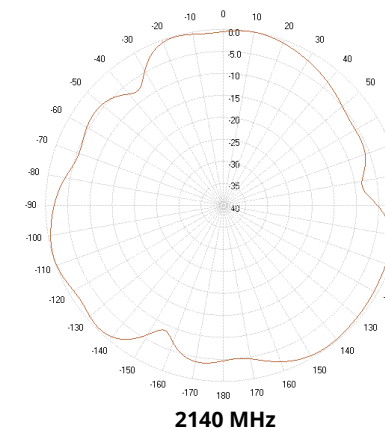
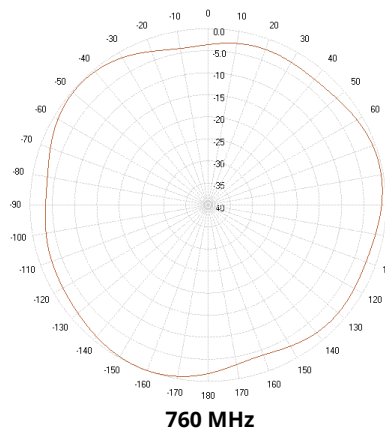

RFD#: 6832 ; Revision: R3 ; Release Date: May 06, 2020

3D Antenna Patterns

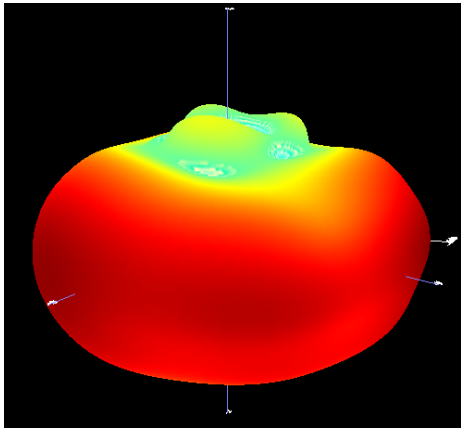

760 MHz

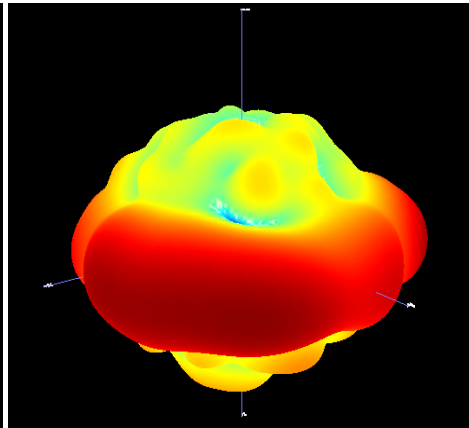

2140 MHz

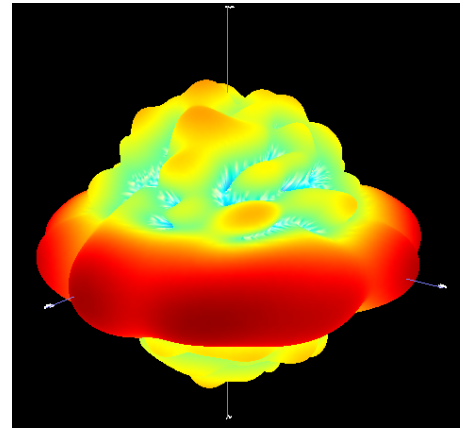

2690 MHz

Antenna Dimension (with MK-06874 Bracket) and Bottom View with Port Labeling

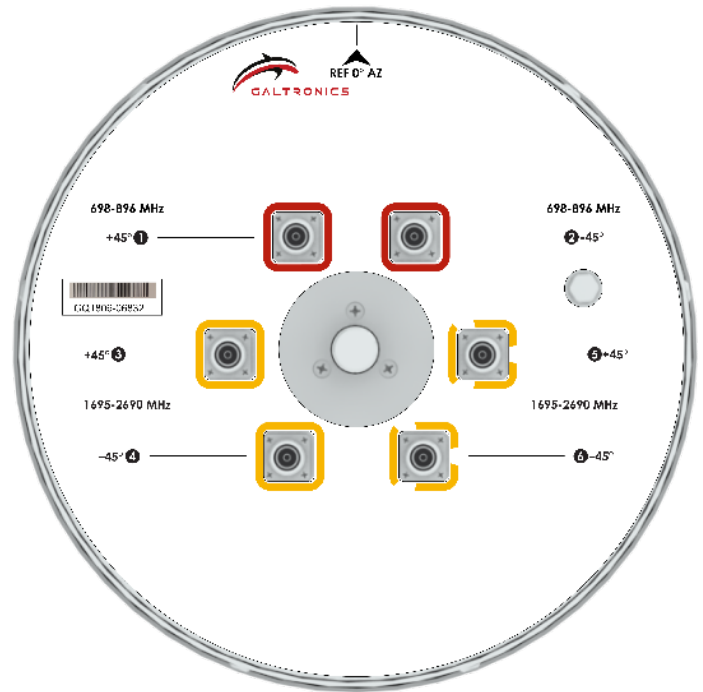
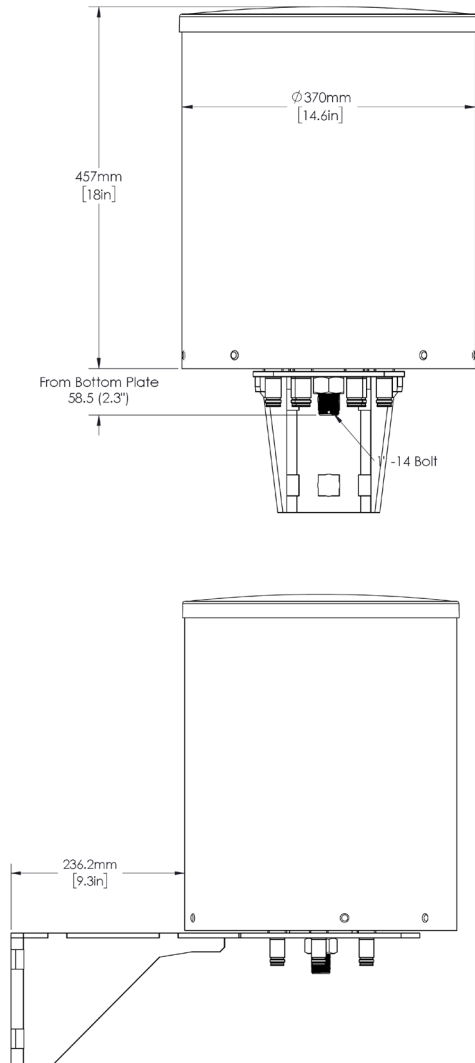

RFD#: 6832 ; Revision: R3 ; Release Date: May 06, 2020



Mechanical Specifications

Operating Temperature	-40° to 158°F (-40° to +70°C)
Antenna Weight	17 lbs (7.7 kg)
Antenna Dimension (Diameter x Height)	14.6" (370 mm) x 18" (457 mm)
Radome Material	ASA
Radome Color	Gray
Ingress Protection	Outdoor (IP65)
Wind Survival Rating	150 mph (241 km/h)

Part Numbers & Ordering Options

Description	Color	Mounting Kit	Part Number
Quasi-Omni Pattern Canister Antenna with 6x 4.3/10 Connectors	Gray	Includes MK-06874 Mounting Kit	GQ1806-06832-112
Quasi-Omni Pattern Canister Antenna with 6x 4.3/10 Connectors	Gray	Includes MK-06761 Mounting Kit	GQ1806-06832-1xx

Mounting Brackets & Optional Accessories

<p>Side Mount Bracket for Canister, Pole Top (wind speed of 150 mph) [INCLUDED WITH -112 OPTION]</p>	 <p>MK-06874</p>
<p>This optional side mount bracket offers an easy installation solution to mount the antenna to the a pole.</p>	
<p>Mounting Kit Assembly, Canister, Pole Top (wind speed of 150 mph) [INCLUDED WITH -1xx OPTION]</p>	 <p>+</p> <p>MK-06761</p>
<p>The assembly kit includes a 1" Mount Rod Adapter (MK-06678: universal interface for pole top installation) and a Pole Top Mounting Bracket (MK-06679: a bracket base attached directly to wood, metal and cement poles).</p>	
<p>Note: 1" Rod Adapter (MK-06678) and Pole Top Mounting Bracket (MK-06679) may be ordered separately.</p>	

Mating Connector Torque:

4.3-10: 3.7 ft-lb (5 Nm)